



ELECTRIC COMBINATION BOILER

(European Patent No: 1757678. Design Right Protected).

TH12-450U M3

This product is suitable for connection to ~230-240V, 50Hz

INSTRUCTIONS FOR USE, INSTALLATION AND SERVICING for all models with serial No beginning 5- TO BE LEFT WITH THE USER

The instructions consist of three parts; **User**, **Installation** and **Servicing** instructions, which include the guarantee registration card.

The instructions are an integral part of the appliance and must, to comply with the current issue of the building, electrical regulations and water by-laws, be handed to the user on completion of the installation.

GUARANTEE REGISTRATION

Thank you for installing a new Thermaflow product in your home.

Thermaflow Ltd appliances, are manufactured to the very highest standards so we are pleased to offer our customers, a comprehensive first year guarantee and a second year parts guarantee.

In the instruction envelope is to be found your guarantee registration card, which must be completed and returned to Thermaflow Ltd or register your Thermaflow appliance for 1st year guarantee protection by calling the below number.

Our guarantee gives you peace of mind valuable protection against breakdown by covering the cost of-

- All replacement parts
- All labour charges
- All call-out charges

THERMAFLOW LTD

Nethercroy Road, Croy, Kilsyth, Glasgow, G65 9JF

Customer services

Tel +44 (0) 1236 722 769
email enquiries@thermaflowheating.co.uk
Web www.thermaflowheating.co.uk



Issue Number: 2a Issue date: February 2012

Copyright Notice

This document contains proprietary information protected by copyright, and this Manual and documentation are copyrighted. All rights are reserved. No part of this document may be photocopied or reproduced by mechanical, electronic, or other means in any form without permission from Thermaflow Ltd.

© Copyright Thermaflow Ltd 2006-12 -All rights reserved.

PART1 – INSTRUCTIONS FOR USE

1.1 INTRODUCTION

This appliance can be used by children aged from 8 years and above and persons with reduced physical, sensory or mental capabilities or lack of experience and knowledge if they have been given supervision or instruction concerning the use of the appliance in a safe way and understand the hazards involved. Children shall not play with the appliance. Cleaning and user maintenance shall not be made by children without supervision

Please read these Instructions and follow them carefully for the safe and economical use of your combination boiler.

This boiler must have been installed by a competent person in accordance with the current rules in force in the countries of destination at the time of installation.

The boiler is automatic in operation once the external controls are set e.g. time clock or programmable room thermostat.

IMPORTANT NOTICE

1.2 Domestic hot water temperature

Hot water is **NOT** user adjustable and is pre-set to 50°C at the thermostatic mixing valve fitted on the hot water outlet at the top left of the boiler. It is TMV3 rated for Anti Scald purposes.

The combination boiler is able to provide room heating as part of an under-floor or central heating system and domestic hot water direct from the cold water supply, without the need for secondary storage.

1.3 To turn the boiler off

To turn the boiler off, isolate the boiler from both the electrical supplies i.e. the 24hr supply and the interrupted supply, both isolating switches should be positioned next to the boiler.

1.4 Maintenance and servicing

To ensure the continued efficient and safe operation of the appliance it is recommended that it is checked and serviced as necessary at regular intervals. The frequency of servicing will depend upon the particular installation conditions and usage, but in general once a year should be enough.

Servicing & maintenance should be carried out by a **competent person** in accordance with the rules in force in the countries of destination.

To obtain service please call your installer or Thermaflow Ltd, using the telephone number on the appliance or at the front of this manual.

Please be advised that the Thermaflow log book should be completed by the installation engineer on completion of commission and servicing.

1.5 Clearances

The boiler requires a clearance in front and at the sides for safety, servicing and maintenance access, see **diagram 2.2.3** for the requirements.

1.6 Draining and filling

Caution this boiler works in a pressurised system which must only be drained, refilled and pressurised by a **person competent to do so**.

Note: if the pressure gauge indicates a loss of pressure that is less than 60 KPA (0.9 bar),

YOU MUST CONTACT YOUR INSTALLER unless you have been instructed by your installer on how to re-pressurise the system correctly.

1.7 Replacement parts

If replacements parts are required, contact your Installer, Service Company or Thermalflow Ltd. Please quote the name and model of your appliance. (Ref. Spare Parts List - section 1.8.1).

It is recommended that the Thermaflow has a safety and maintenance check on an annual basis.

A pressure reducing valve must be fitted to the cold water inlet of the appliance if the incoming pressure exceeds 300kPA (3 Bar).

The position of the outlet from the discharge pipe shall be visible to the occupants and shall be positioned away from any electrical devices.

The position of discharge pipes, (Tundish), drain valves and motorised valves etc, must be positioned away from electrical components.

The water may drip from the discharge pipe of the pressure-relief device and must be left open to the atmosphere.

The pressure relief device must be operated regularly to remove lime deposits and to verify that it is not blocked.

The discharge pipe connected to the pressure-relief device must be installed in a continuously downward direction and in a frost free environment.

DANGER: Failure to operate the relief valve easing gear at least every six months may result in the water heater exploding. Continuous leakage of water from the valve may indicate a problem with the water heater

IMPORTANT: If any external heat sources are being connected to the water heater, they must be connected as detailed in this instruction manual. There must be temperature control thermostats fitted to control each heat source and must be set to a **maximum temperature of 80°C**

(Additional Information given in G3 of the building regulations for discharge pipes)

Contents

PART1 – INSTRUCTIONS FOR USE.....2

1.1 INTRODUCTION.....2

1.2 Domestic hot water temperature.....2

1.3 To turn the boiler off2

1.4 Maintenance and servicing.....2

1.5 Clearances.....2

1.6 Draining and filling.....3

1.7 Replacement parts3

0.1 Instructions General.....6

0.2 Draining & Filling.....7

0.3 Manual Handling Guidance.....7

0.4 TESTING & CERTIFICATION.....7

0.5 THE UNIT LOCATION7

0.6 Water Connections.....8

1.8 Thermaflow TH Model MK2.....Error! Bookmark not defined.

TABLE 1.8.1 [DATA].....10

Part 2 – INSTALLATION.....11

2.1.1 Sheet metal parts11

2.1.2 Statutory requirements.....11

2.1.3 DATA 11

2.1.4 ELECTRICAL SUPPLY11

2.1.5 Electrical supply.....12

2.1.6 Heating system controls.....12

2.2.1 Boiler Position.....12

2.2.2 Boilers in a compartment13

2.2.3 Clearances allow for external primary heat transfer kit14

2.3.1 General notes14

2.3.2 Safety valve14

2.3.3 Pressure & Temperature Gauge.....14

2.3.4 Pump 14

2.3.5 Expansion vessel14

2.3.6 By- pass.....14

2.3.7 Filling sealed systems14

2.3.8 Corrosion inhibitor.....14

2.3.9 Draining15

2.4. Domestic hot water system.....15

2.4.1 General 15

2.4.2 Water pressure.....15

2.4.3 HOT WATER FLOW RATE15

2.4.4 Hard water areas15

2.5. Installation, PREPARATION [water connections].....15

2.5.1 Water connections15

2.5.2 SAFETY VALVE DISCHARGE16

2.6 ELECTRICAL INSTALLATION REQUIREMENTS.....16

IMPORTANT 16

2.6.1 ELECTRICAL SUPPLY17

2.6.2b OFF-PEAK & 24 HR WIRING CIRCUITS18

2.6.3 External Controls20

ELECTRICAL CONNECTIONS20

2.6.4 Supply cable connection [24 HR Supply]20

2.6.5 Heating system controls.....20

2.6.6 Electrical Test	21
2.6.7 Supply cable connection [Interrupted off peak supply]	21
2.6.8 Electrical Test	21
2.6.9 IMPORTANT: Electricity tariffs	21
2.7 Commissioning	22
2.7.1 Filling domestic water circuit	22
2.7.2 Filling the heating system	22
2.7.3 Domestic hot water flow rate.....	22
2.7.4 Temperature settings	22
2.7.5 Heating system commissioning.....	23
2.7.6 Completion	23
2.7.7 INSTRUCT THE USER	23
Part 3 - SERVICING	24
3.1. Fault Finding	24
3.1.1 Fault: No domestic hot water or central heating	25
3.1.2 Fault: No central heating, but hot water at taps.....	26
3.1.3 Fault: CENTRAL HEATING BUT No hot water at taps.....	27
3.2 MAINTENANCE	30
Checking the pressure in the expansion vessel	30
3.2.3 Checking the inline strainer.....	30
3.2.4 Checking the hot water blending valve.....	30
3.2.5 Checking the concentration of corrosion inhibitor.....	31
3.2.6 Preventing pump seizure in summer.....	31
3.2.7 Checking correct operation of electrical components	31
3.2.8 Low pressure switch	31
3.2.9 Control and high limit manual re-set thermostats	31
3.2.12 Checking the heating elements.....	32
3.2.13 Checking circuit breakers.....	32
3.2.14 Checking the contactor	32
3.2.15 Check the operation of the AQUA STAT	32

IMPORTANT PRE-INSTALLATION NOTES

- Power supply and wiring

The power supply to the premises must meet the minimum requirements of the unit being installed, with special attention given to the supply current, cable size and MCB recommendation. The supply voltage to the appliance must never drop below 207 Volts.

Important

The electrical supply requirements:-

The 9 KW and 12 KW boilers meet the requirements of EN 61000-3-11

The equipment is intended for use only in premises having a service current capacity of $\geq 100A$ per phase , supplied from a distribution network having a nominal voltage of 400/230 V, and the

user should consult the supply authority if necessary to determine if the service current capacity at the interface point is sufficient for the equipment.

0.1 Instructions General

A pressure reducing valve must be fitted to the cold water inlet if the incoming water pressure exceeds 300 KPA (3.0 Bar).

The primary operating pressure initial charge is 120 KPA (1.2 bar) this will increase to around 200 KPA (2.0Bar) when the system has reached maximum temperature and will depend on system volume.

The primary expansion is internal and is formed when the vessel is initially filled. It has a volume of 42L.

The secondary expansion vessel pre-charge pressure is between 200-350 KPA (2-3.5 bar) and has a volume of 0.5 litres.

The primary pressure relief valve is set to 300 KPA (3.0 Bar).

	Thermaflow Model Number
	TH12-450U M3
Primary storage capacity	450 Litres
Weight when Empty	120 Kg
Weight when Full	570 Kg

WARNING: BEFORE OBTAINING ACCESS TO TERMINALS, ALL SUPPLY CIRCUITS MUST BE DISCONNECTED.

The **TH12** has **4** heating elements fitted. Size 16" in length and are manufactured from Inc-alloy EN60335.2.73.

The rated power input of the **TH12** appliance is ~230-240V, 50Hz, 10800-12000w

The elements fitted to the Thermaflow should NOT be replaced with elements which are not approved for the Thermaflow boiler.

0.2 Draining & Filling

CAUTION: THE THERMAFLOW BOILER WORKS IN A PRESSURISED SYSTEM WHICH MUST ONLY BE DRAINED, REFILLED AND PRESSURISED BY A COMPETENT PERSON.

There is a drain tap fitted to the Thermaflow boiler to drain the primary circuit within the boiler it is located at the bottom of the appliance.

Further drain taps should be fitted into the pipe-work at the lowest point of the potable water circuit and the heating circuit and should terminate outside the dwelling in a suitable position.

0.3 Manual Handling Guidance

During the appliance installation it will be necessary to employ caution and assistance whilst lifting as the appliance exceeds the recommended weight for a one man lift.

DO NOT LIFT THE APPLIANCE BY ATTACHED PIPE-WORK OR COMPONENTS

In certain situations it may be required to use a mechanical handling aid.

Take care to avoid trip hazards, slippery or wet surfaces.

IMPORTANT INFORMATION

0.4 TESTING & CERTIFICATION

The boiler is tested and certified for safety and performance. It is therefore important that no alteration is made to the boiler, without permission, in writing, from Thermaflow Ltd.

Any alteration not approved by Thermaflow Ltd, could invalidate the certification, boiler warranty and may also infringe the current issue of the statutory requirements, see section 2.1.2

The unit should be stored in a dry environment and should be handled with care to prevent attached components being damaged or connections becoming loose. **All connections should be checked for leaks after installation.**

0.5 THE UNIT LOCATION

The unit should be preferably located in a cupboard with a minimum dimension of;

L 825mm x B. 890mm x H. 2.4M

The floor to which the unit is placed upon should be capable of withstanding a load of:

570KG

The unit should be positioned in a manner that allows access to all components for future maintenance.

If located in a cupboard the unit should be positioned with all components facing the entrance to allow elements to be replaced if required or any of the other components.

0.6 Water Connections

There are six water connections to be made when installing the Thermaflow.

They are as follows:

- 1) Flow and return connections to the heating system are 22mm compression.**
- 2) Cold water inlet-22mm compression.**
- 3) Hot water outlet -22mm compression.**
- 4) Pressure relief valve- 15mm compression.**
- 5) The pressure relief valve connection should be used for no other purpose.**
- 6) The heating expansion vessel- 22mm compression.**

Component List & description

THERMAFLOW

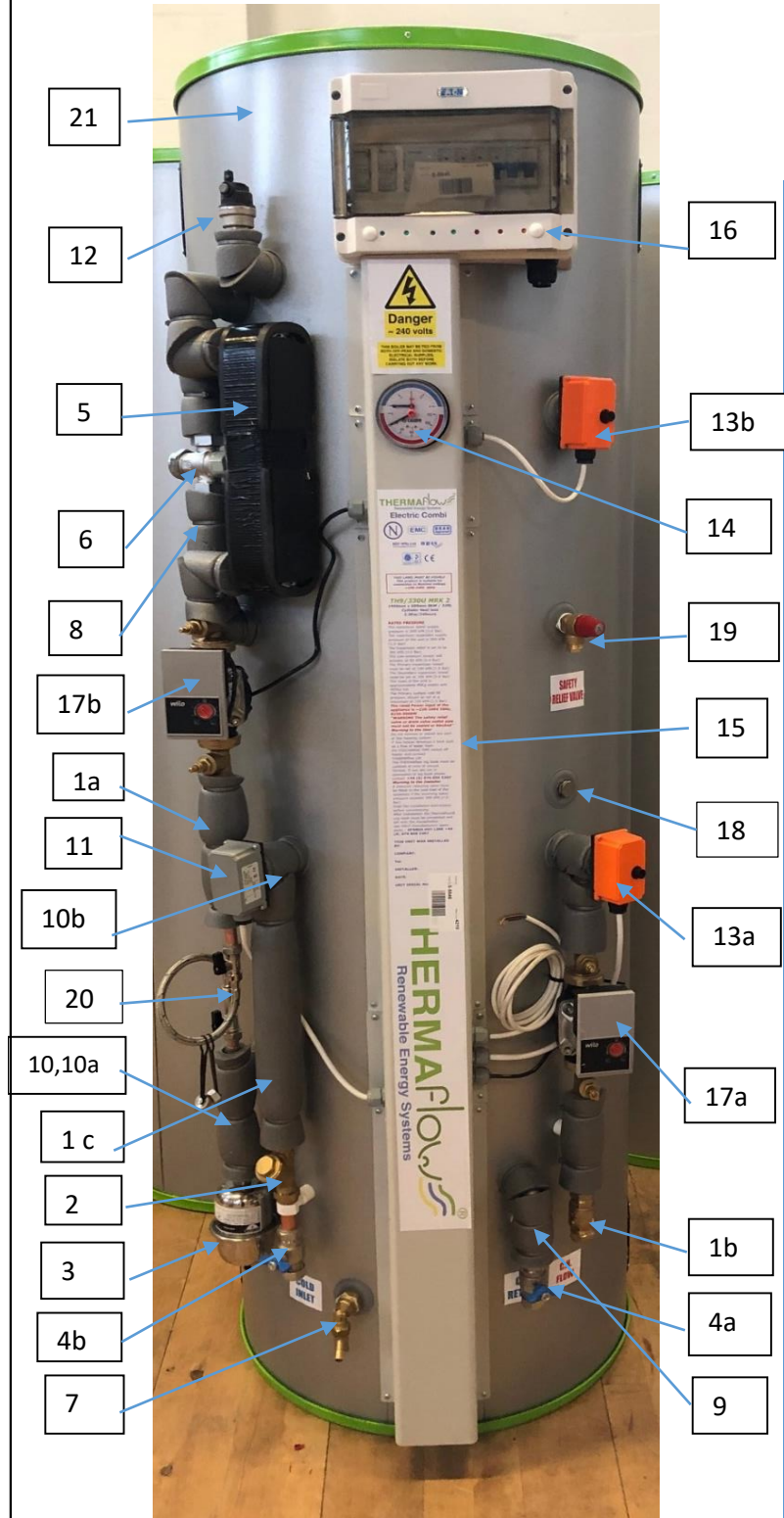

1a	Single check valve, HW, Primary Circuit
1b	Single check valve, CH Flow, Primary Circuit
1c	Single check valve, cold inlet, secondary Circuit
2	'Y' Pattern strainer, cold inlet, secondary circuit
3	0.5L expansion vessel, secondary circuit
4a	22mm isolating valve, CH return
4b	22mm isolating valve, cold inlet, secondary circuit
5	Brazed Plate Heat Exchanger, primary and secondary circuit
6	Thermostatic Mixing Valve, secondary circuit
7	Drain point primary circuit
8	Cold supply to mixing valve, secondary circuit
9	Additional primary expansion vessel position if required
10	Tee cold water inlet, secondary circuit
10a	Tee cold water inlet, secondary circuit
10b	Tee and phial pocket, cold water inlet, secondary circuit
11	Aqua-stat sensor for switching between heating and hot water pumps
12	Auto Air eliminator
13a	Manual re-set overheat thermostat
13b	Manual re-set overheat thermostat
14	Temperature and pressure gauge
15	Cover panel for housing heating elements, temperature control thermostats, low water pressure switch, wiring loom and electrical connections
16	Electrical switchgear, MCB's and Contactors
17a	Primary circuit circulating pump for central heating
17b	Primary circuit circulating pump for hot water
18	½" BSP for primary water temperature and overheat thermostat position
19	Safety Relief valve (Primary) 3 bar
20	Filling loop assembly for filling primary circuit
21	Duplex stainless steel vessel

TABLE 1.8.1 [DATA]

	TH12-450U M3
Lift Weight empty	110KG
Total Weight boxed	120KG
Weight Full	570KG
Heating Flow & Return	22mm Compression or push fit
Domestic Cold Water Inlet	22mm Compression
Domestic Hot Water Outlet	22mm Compression
Safety Relief Valve	PRESET 300 KPA (3.0 Bar)
Safety Relief Valve Discharge	15mm Compression
Water Content Primary	450
Water Content Domestic (Secondary)	2 Litres / 0.44 Gallons
Primary Expansion INTERNAL	42 Litres 9.2 Gallons
Secondary Expansion Vessel	0.5 Litres/0.11 Gallons
CH Cold Fill Pressure Min/Max	90 KPA (0.9 Bar) minimum / 120 KPA (1.2 Bar) maximum
D.H.W Working Pressure	20 – 300 KPA (0.2-3.0 Bar)
Max. CH system Content (Excluding unit volume)	170Litres
Electrical Mains Supply	~230-240V, 50Hz
Electrical Rating (Interrupted) & Supply Current	TH12/ 10800-12000w – 52 amp
MCB Rating (amp)	12Kw (52amp) 40A or 63 A TYPE 'B' MCB
Electrical Rating (24Hr) Control Circuit	95w, Fused 3amp or 6A Type B MCB

PART 2 – INSTALLATION

2.1.1 Sheet metal parts

Warning: when installing or servicing this boiler care should be taken when handling the edges of metal parts to avoid any possibility of personal injury.

2.1.2 Statutory requirements

The installation of this boiler must be carried out by a competent person in accordance with the current rules in force in the countries of destination at the time of installation, and in accordance with the relevant requirements of the current issue of:

The Building Regulations

The Local Water Company bye-laws

The Building Standards Regulations (Scotland)

The Health and Safety at Work Act

Manufacturer's instructions, supplied

Manufacturer's instructions must not be taken as overriding statutory requirements.

2.1.3 DATA

The data label is on the front case of the boiler.

2.1.4 ELECTRICAL SUPPLY

- **Power supply and wiring**

The power supply to the premises must meet the minimum requirements of the unit being installed, with special attention given to the supply current, cable size and MCB recommendation. The supply voltage to the appliance must never drop below **207 Volts**.

Important:

The electrical supply requirements:-

All 12 KW boilers meet the requirements of EN 61000-3-11

All 12 KW boilers must be installed in premises having a service supply of $\geq 100A$ per phase.

WARNING: This boiler must be earthed

WARNING: Means for disconnection must be incorporated in the fixed wiring in accordance with the wiring rules

WARNING: Electrical work must be carried out by a person competent to do so

All system components shall be of an approved type.

The electrical installation shall be in accordance with the current rules in force in the countries of destination at the time of installation.

2.1.5 Electrical supply

Means of disconnection of the electrical supply to the boiler must be incorporated in the fixed wiring in accordance with the wiring rules.

Two isolators are required at the boiler when using an interrupted off peak supply eg. E2000, one for the 24hr supply, and the other for the interrupted supply (off peak if available).

If using Scottish & Southern Energy, only one isolator is required at the boiler.

Means of disconnection of the 24hr supply should be by a double pole switched fused spur (fuse rating 3 amp), having a minimum contact separation of 3mm in each pole. The fused spur should be readily accessible and adjacent to the appliance. It should be identified as to its use.

Means of disconnection should not be fitted in a room containing a fixed bath or shower. The 24hr mains supply cable and other cables for external controls must be heat resistant and flexible PVC type of at least 0.75mm² (24/ 0.20mm)

Means of disconnection of the interrupted supply (off peak) should be by a double pole switched (60amp isolator with a 40 amp MCB **Type B** for the **TH9/** model) and a switched (100 amp isolator with a 63 amp MCB **Type B** for the **TH12/** model), having a minimum contact separation of 3mm in each pole. The switched isolator and MCB should be readily accessible and installed at the origin of the supply to the boiler. It should be identified as to its use.

Means of disconnection should be readily accessible and adjacent to the appliance. It should be identified as to its use.

The interrupted mains supply cable must have a cross sectional area of at least (10mm² for the TH9/ model) (16mm² for the TH12/ model). The mains supply cable at the boiler location should be preferably encased by flexible conduit.

2.1.6 Heating system controls

The heating system should have installed: A timer and room thermostat or a programmable room thermostat controlling the central heating system or under-floor heating.

If an under-floor heating system is being installed it must have its own pump and blending valve. Thermostatic radiator valves should be installed in addition to the room thermostat for better economy and energy saving.

2.2.1 Boiler Position

The boiler must be installed in accordance with the rules in force in the countries of destination. This boiler is not suitable for fitting outside.

Any electrical switch must be positioned so that it cannot be touched by a person using a bath or shower.

The boiler must be positioned on a level base or floor which is sufficiently robust to take its weight, (Refer to table 1, "Data")

If the location of the boiler or any part of the system is subject to severe cold weather conditions, it is recommended that a frost thermostat is fitted. Any part of the system that may be vulnerable to freezing must be protected.

2.2.2 Boilers in a compartment

Where the installation of the boiler will be in an unusual position, the current issue of BS 6798 gives detailed guidance on these requirements.

An existing cupboard or compartment modified for the purpose may be used, providing minimum clearances are maintained. Details of essential requirements for cupboards or compartment design are given in the current issue of BS6798.

The doorway opening should be of sufficient size to allow for easy removal of the boiler.

Where the boiler is fitted in a cupboard or compartment, permanent ventilation is not necessarily required and will depend on compartment size and airflow around the boiler.

Compartment ventilation is required to dissipate heat from any external heating circuit pipe-work, to prevent overheating of the electrical components and wiring.

Any existing compartment air vents must not be removed or blocked off.

2.2.3 Clearances

The boiler should be positioned so that at least the minimum operational and servicing clearances are provided, see diagram 2.2.3 additional clearances may be required around the boiler for installation. A clearance of 600mm is required at the front of the boiler for maintenance and installation.

2.3.1 General notes

The boiler is intended for use in a sealed system only.

2.3.2 Safety valve

The safety relief valve is an integral part of the boiler. It cannot be adjusted but has a manual test device.

2.3.3 Pressure & Temperature Gauge

A pressure and temperature gauge is incorporated into the boiler to indicate the system pressure and temperature. The gauge has a cold fill set pointer.

2.3.4 Pump

The circulation pump is integral with the boiler.

2.3.5 Expansion vessel

The 450L unit has **42 litres of internal** expansion. If the water content of the heating system exceeds the maximum quoted in **table 1**, [Data] an additional expansion vessel should be connected into the system as close as possible to the central heating return connection of the boiler. **Ref. Diagram 2.3.5**

The charge pressure shall not be less than the static head at the point of connection, which is the height of the top point of the system above the expansion vessel.

2.3.6 By- pass

An automatic by- pass valve should be incorporated in the system for maximum system efficiency. (A By-Pass MUST be fitted to the system by the installer).

2.3.7 Filling sealed systems

The boiler has a filling loop incorporated within it, and pressure gauge to register the fill pressure.

There must be no permanent connection to the mains water supply; even though a non-return valve is supplied. **Disconnect filling loop and seal both valves with suitable caps.**

2.3.8 Corrosion inhibitor

The maintenance of sufficient concentration of corrosion inhibitor in your Thermaflow system is vital to prevent corrosion. We would recommend sentinel X100, or equivalent. Dose appropriately according to the size of the Thermaflow boiler and central heating system volume combined.

Diagram 2.2.3 - Clearances

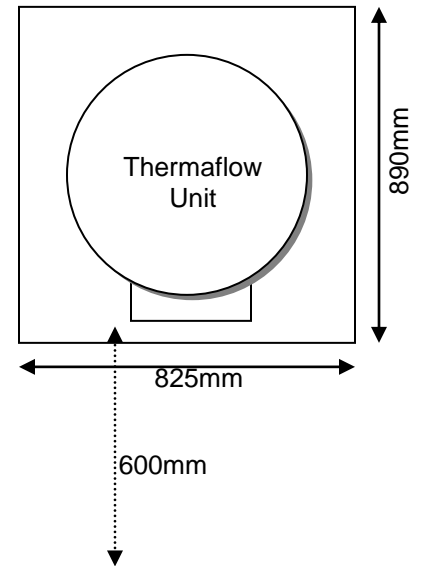
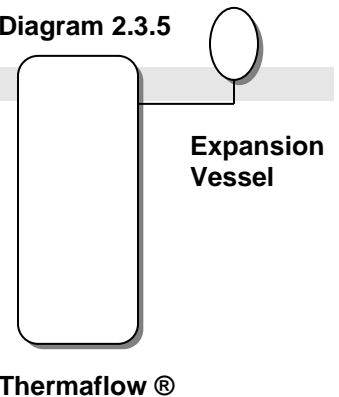

Diagram 2.3.5



2.3.9 Draining

A draining tap must be provided at the lowest points of the system, which will allow the entire system to be drained.

The boiler has a drain tap fitted for draining of the primary circuit.

2.4. Domestic hot water system

2.4.1 General

The domestic hot water service must be in accordance with the rules in force in the countries of destination.

2.4.2 Water pressure

For the minimum and maximum, working pressures of the domestic hot water circuit of the boiler refer to (“data” table 1).

If the cold water inlet pressure exceeds 300 KPA (3 bar) a pressure reducing valve must be fitted to the inlet to the boiler.

2.4.3 HOT WATER FLOW RATE

The boiler is capable of flow rates of **15-25 litres per/min @ 35°C Δt (depending on model)**. Hot water flow rate and pressure will be determined by the volume and pressure of the incoming cold water supply and the primary store temperature.

2.4.4 Hard water areas

In areas where the water is “Hard” more than 200 mg / litre, it is recommended that a proprietary scale reducer or water softener is fitted in the cold water supply to the boiler depending on what is necessary to prevent lime scale build up in the heat exchangers, pipe-work or valves. Consult the local water authority for additional advice.

A double check valve assembly must be fitted upstream of the scale reducer or water softener. For the relative position of the scale reducer or water softener and pressure reducing valve if required, refer to the Manufacturer’s instructions.

2.5. Installation, PREPARATION [water connections]

2.5.1 Water connections

See General Data Diagram 1.8.1 & table 1.8.1 for pipe work connections

It is recommended to flush out the domestic water and heating system before connecting to the boiler.

While making the connections, do not subject any of the connections to heat as you may damage the seals.

2.5.2 SAFETY VALVE DISCHARGE

It must not discharge above an entrance or window or any type of public access. The position of the discharge outlet shall be visible to the occupants and shall be positioned away from any electrical devices.

The position of discharge pipes (Tundish) drain valves and motorised valves etc must be positioned away from electrical components.

The water may drip from the discharge pipe of the pressure-relief device and must be left open to the atmosphere.

The pressure relief device must be operated regularly to remove lime deposits and to verify that it is not blocked.

The discharge pipe connected to the pressure-relief device must be installed in a continuously downward direction and in a frost free environment.

The connection for the discharge is made at the bottom side of the safety relief valve.

This must be extended from the safety relief valve with not less than 15mm O.D. metal pipe, to discharge, in a visible position, outside the building, facing downwards, preferably over a drain. The pipe must have a continuous fall and be routed to a position so that discharge water, possibly boiling or steam, cannot create any danger to persons, damage to property or external electrical components and wiring.

2.6 ELECTRICAL INSTALLATION REQUIREMENTS

- **Power supply and wiring**

The power supply to the premises must meet the minimum requirements of the unit being installed, with special attention given to the supply current, cable size and MCB recommendation. The supply voltage to the appliance must never drop below **207 Volts**.

IMPORTANT

THE ELECTRICAL SUPPLY REQUIREMENTS:-

The 12 KW boilers meet the requirements of EN 61000-3-11

The 12 KW boilers must be installed in premises having a service supply of $\geq 100A$ per phase.

2.6.1 ELECTRICAL SUPPLY

IMPORTANT

If the boiler is wired to the Scottish Power Domestic & Economy 200 tariff, it requires two separate ~230-240V power supplies. A (24HR) supply for controls and an interruptible supply for the boiler. **(Off Peak power supply if it is available).**

The off peak or interruptible mains supply is wired according to the following **diagram 2.6.1**, from the 63 amp double pole isolator by way of flexible 16mm² cable into the main terminals in enclosure marked **No. 16** on the boiler schematic on **page 9** of this instruction manual, see **diagram 2.6.1b** on **page 18**.

If the boiler is wired to a 24 hour tariff or Scottish & Southern Energy Economy 10 tariff for wet electric central heating then a separate 3 amp supply is not required for the controls as the controls are supplied via the 6 amp MCB in the control box marked **No.16** on the boiler schematic on **page 9** of this instruction manual, see **diagram 2.6.1b** on **page 18**.

A Local isolator may also be required at the boiler position.

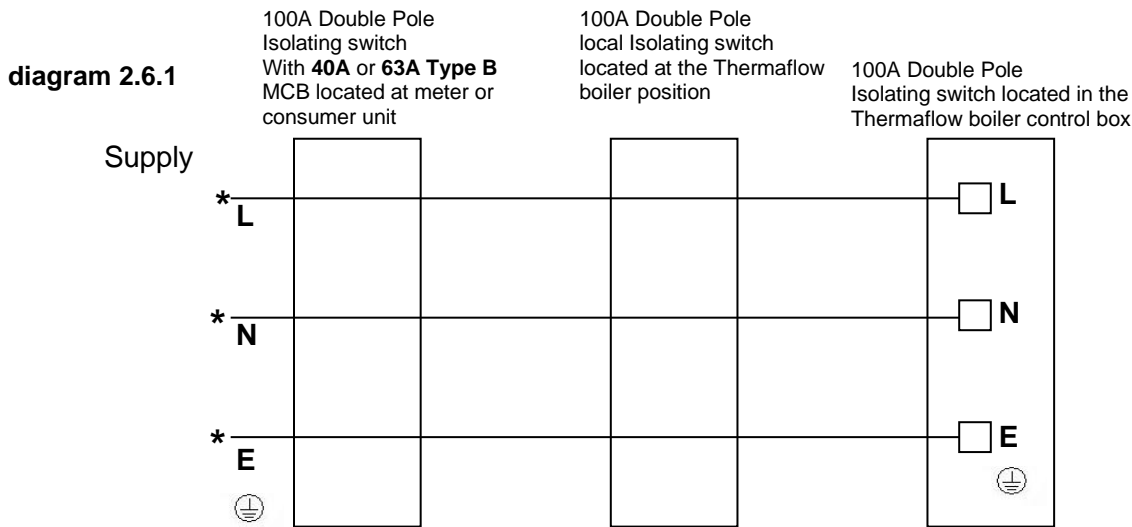

* 25mm² COLOUR CODED METER TAILS
CONNECT TO METER / TELE-SWITCH

CABLE SIZING

Boiler rating minimum Cable Size ~230-240V-50Hz, 8250-9000w – **10mm²**, 11000-12000w – **16mm²**.

MCB MUST BE TYPE B.

2.6.2

The mains supply into the boiler shown in the diagram on **page 9**, should be wired to the 24HR supply via 3 Amp fused isolating switch located at the boiler, **ref. diagram 2.6.2b**.

2.6.2b OFF-PEAK & 24 HR WIRING CIRCUITS

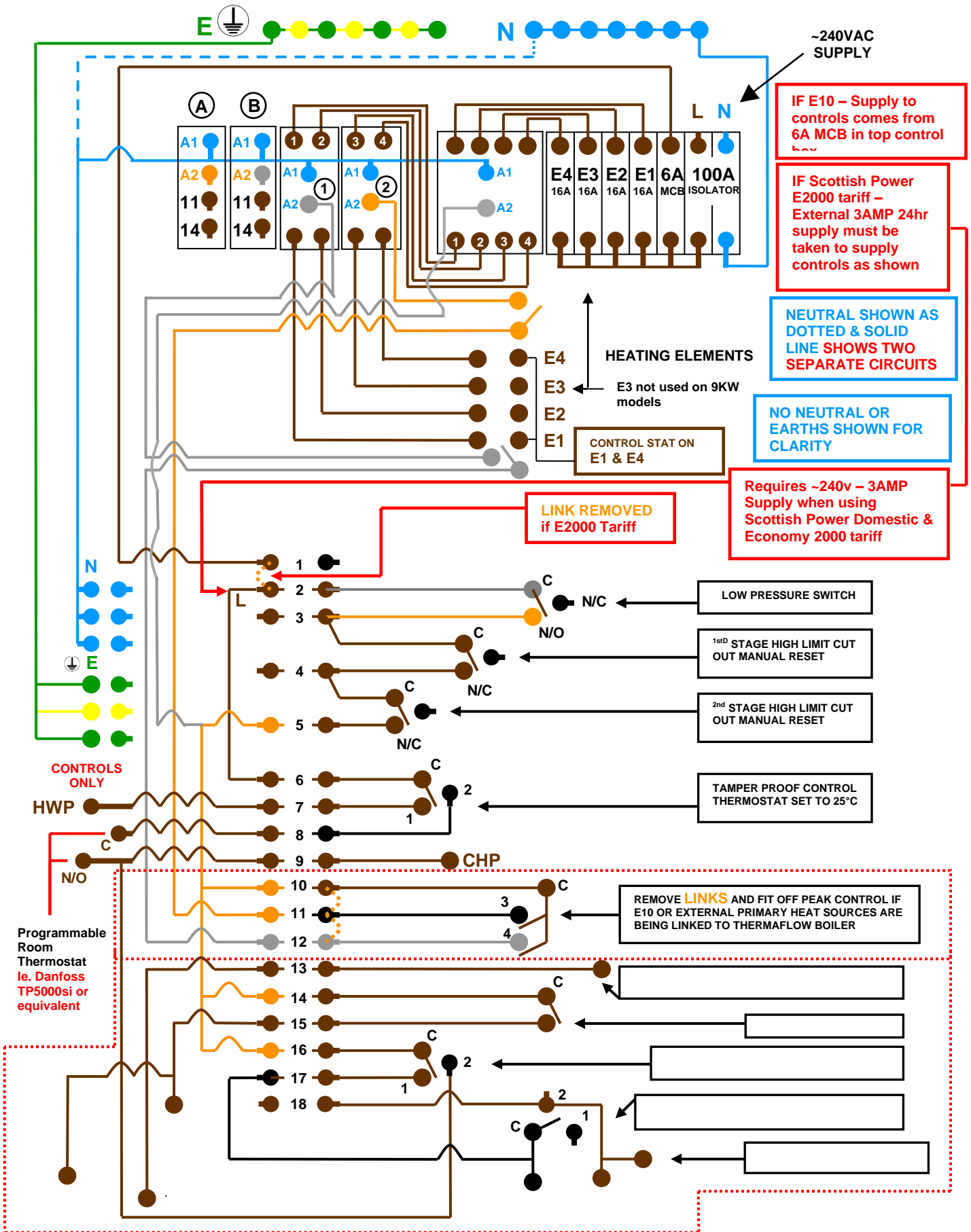

2.6.2c OFF-PEAK TIMER & WIRING CIRCUIT

OFF PEAK TIMER

The Off Peak Control allows you to time the boiler to charge during the reduced rate periods on wet electric central heating tariffs



Off Peak Timer required when using E10 wet electric tariff or similar or when linking external primary heat source to the Thermaflow boiler

The control allows you to reduce running costs substantially.

The winter channel controls the timing of the bottom two elements on all Thermaflow boiler models via contactor 1 on the Thermaflow boiler

The summer channel controls the timing of the top element on a 9kw Thermaflow boiler and the top two elements on the 12kw boiler via contactor.

All Connections are ~240V AC

IMPORTANT

Use the piece of 5 core heat resistant flex supplied with the programmer.

Connections onto main wiring terminal on boiler.

Off Peak Timer

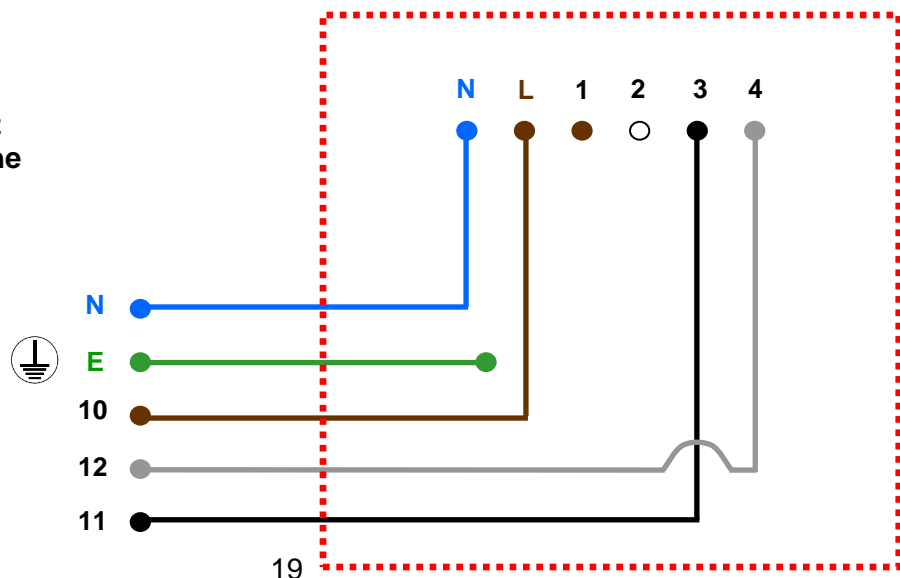

2.6.3 External Controls

External heating controls should be connected to the appropriate terminals numbered in **diagram 2.6.2b**.

WARNING: ALL EXTERNAL CONTROLS MUST NOT BE TAKEN FROM ANY OTHER POWER SUPPLY OTHER THAN VIA THE 3 AMP FUSED ISOLATING SWITCH MENTIONED ABOVE.

ELECTRICAL CONNECTIONS

2.6.4 Supply cable connection [24 HR Supply]

Caution: To prevent an induced current from switching the central heating on when not required it is important that the heating system control cables are separated from the other mains cables.

There is provided 1 or 2 heat resistant cables extending from the main panel situated between both circulating pumps depending on the tariff being used. One cable has 3 cores. Live, Neutral and earth to be connected to a 3 amp double pole fused isolator.

The other cable has 2 cores coloured brown and (blue core covered with brown sleeve) these are both common live and switched live wires to be connected to external heating controls.

If the boiler is being connected to SSE E10 tariff the 3 core flex if already fitted, must be removed and a link fitted between terminal 1 & 2 as shown in diagram 2.6.2b on page 18.

It is also advisable to fit the off-peak control when using a wet electric tariff other than Domestic & Economy 2000 to enable a reduction in running costs.

IMPORTANT

If the boiler is connected to Scottish Power Domestic & Economy 2000 tariff it requires a permanent mains supply through an external isolator (rated to 3amp) which must isolate any heating system controls see diagram 2.6.2b

Any heating system controls must not interrupt the mains supply to the boiler.

Standard colours are **Brown- Live, Blue- Neutral and Green and yellow- Earth**. Make the earth cable of a greater length so that if the cable becomes strained the earth would be the last to become disconnected.

CAUTION: IT IS ESSENTIAL TO MAKE SURE THAT THE POLARITY IS CORRECT.

2.6.5 Heating system controls

All external controls and wiring are required to provide a minimum of reinforced insulation at 250 vrms between the parts of those devices operating at mains hazardous voltage and the user accessible parts of those devices.

Note: for further information, see the building regulations 1991- conservation of fuel and power, 1995 edition- appendix G, table 4B.

When any kind of external heating system controls are being used to regulate the heating system connect a single pole type, to the appropriate terminals of the connector shown in **diagram 2.6.2b, or (to the 2 core cable provided)**.

If the installation requires protection by a "Frost Thermostat" connect a single pole type, **between terminals 6 and 9** shown in **diagram 2.6.2b**.

2.6.6 Electrical Test

Carry out preliminary electrical system checks as below.

- 1) Test insulation resistance to earth of mains cables.
- 2) Test earth continuity and short circuit of all cables.
- 3 Test the polarity of the mains.
- 4 Refit the enclosure cover.

2.6.7 Supply cable connection [Interrupted off peak supply]

Open the enclosure situated at the top of the boiler.

Using 16mm² twin and earth cable of a suitable length route the mains interrupted supply cable through a piece of suitably sized flexible conduit into the 100amp isolator shown in diagram 5.

Standard colours are Brown- Live, Blue- Neutral and the earth should be sleeved with a suitably sized green and yellow earth sleeve.

Make the earth cable of a greater length so that if the cable is strained the earth would be the last to become disconnected.

CAUTION: IT IS ESSENTIAL TO MAKE SURE THE POLARITY IS CORRECT.

2.6.8 Electrical Test

Carry out preliminary electrical system check as below:

- 1) Test insulation resistance to earth, of mains cables.
- 2 Test earth continuity and short circuit of all cables
- 3 Test the polarity of the mains.
- 4 Refit the enclosure cover.

2.6.9 **IMPORTANT:** Electricity tariffs

The Thermaflow will operate on any ~230-240V, 50Hz supply. **The most economical option is a peak avoidance tariff as described previously.**

Compare various supplier's tariffs to ensure the best economic operation.

2.7 Commissioning

2.7.1 Filling domestic water circuit

Check that the boiler is isolated from the electrical supply, at both external isolators.

Fully open the domestic water supply stop cock or valve in the supply to the boiler.

Open all hot water draw-off taps and close them when water flows.

Check for water soundness of the whole domestic hot water installation and boiler.

2.7.2 Filling the heating system

Flush, fill and vent the system refer to section 3.7 “Filling sealed systems”.

The boiler and central heating system should be completely filled and purged of air before switching on the power to the appliance. The cold fill pressure should register no more than 150 KPA (1.5 Bar). **See Table 1.8.1 (DATA), for minimum and maximum pressures.**

Make sure the automatic air vent at the top of the boiler is operating correctly.

IMPORTANT!

MAKE SURE THE BOILER AND SYSTEM IS COMPLETELY FULL OF WATER AND ALL AIR IS ELIMINATED BEFORE TURNING ON ANY OF THE POWER SUPPLIES TO THE BOILER.

Take care not to splash any of the electrical components.

Pressurise the system until the pressure is 120 KPA (1.2 Bar). **Check the heating system and boiler for water soundness.**

Check the operation of the safety valve by turning the safety valve knob in the direction of the arrow.

Lower the pressure to the initial cold fill design pressure of 120 KPA (1.2 Bar), **refer to table 1.8.1.** Position the set pointer on the boiler pressure gauge at this pressure also.

NOTE: When the boiler reaches its maximum temperature, the pressure will increase to around 200 KPA (2.0 Bar)

2.7.3 Domestic hot water flow rate

The domestic hot water flow rate can be set by adjusting the stop cock on the cold water inlet to the boiler.

2.7.4 Temperature settings

The maximum temperature setting for the domestic hot water is pre-set at 50°C to prevent scalding and is not user adjustable.

The maximum flow temperature setting for central heating is 82°C this is the pre-set and is not adjustable.

2.7.5 Heating system commissioning

Make sure the boiler and heating system is completely full of water. (SEE ABOVE SECTION 7.2)

Turn on both 24Hr & Interrupted power supplies. Allow approximately 120 - 300 minutes to bring the boiler up to temperature (depending on model). Check that all external controls, are calling for heat.

Fully open all thermostatic and lock shield valves on each radiator.

The aqua stat, positioned at the bottom of the boiler is pre-set to **30°C (It must remain at this setting)**

Allow this system to reach maximum temperature then switch off both electrical supplies at the isolators. Drain the system rapidly while still hot.

Fill and vent the system as described in section 7.2 "Filling the central heating circuit" Add inhibitor as required refer to section 3.8 "Corrosion Inhibitor"

Set to the initial cold fill design pressure, using the external draining tap. Refer to table 1, and section 3.9

NOTE: The system fill pressure may require to be recharged once or twice in the first two to three weeks after the initial commissioning of the boiler due to oxygen and air content in the system being expelled through the automatic air eliminator.

There should be no further need to re-pressurise the system after this period. If the system requires continuous re-pressurisation, there may be a leak in the installation.

2.7.6 Completion

Set any external heating control to the desired settings.

2.7.7 INSTRUCT THE USER

Instruct and demonstrate the isolating switches then advise the user of the efficient and safe operation of the boiler.

Instruct and demonstrate the operation of any heating system controls.

Advise the user on the use and maintenance of any scale reducer or water softener and pass on any relevant instructional documents.

Advise the user that to ensure continued efficient and safe operation of the appliance, it is **recommended** that it is checked and serviced at regular intervals. The frequency of servicing will depend on the particular installation and usage, but in general once a year should be enough.

Any servicing should be carried out by a person competent to do so.

Advise the user of the precautions necessary to prevent damage to the system and building in the event of the heating system being out of use during frost and freezing conditions.

Reminder- leave these instructions with the user.

Advise the user that the logbook should be completed by the engineer on completion of commissioning. **Failure to do so will invalidate the warranty.** The user must sign the log book and retain it for future reference.

PART 3 - SERVICING

3.1. Fault Finding

MUST BE CARRIED OUT BY A PERSON COMPETENT TO DO SO

Before trying to operate the boiler make sure that:

The heating system pressure is at 120 KPA (1.2 Bar) when the system is **COLD** and 200 KPA (2.0 Bar) when the system is at **maximum** temperature.

There is a permanent mains power, (24hr supply) to the terminals marked in the control panel on the boiler in the schematic diagram on **page 9** of this instruction manual.

There is power at the off peak (Interrupted) supply main switch in the control box at the top of the boiler (Marked No 17 on the boiler schematic diagram on **page 9** of this instruction manual.

WARNING: BEFORE OBTAINING ACCESS TO TERMINALS, ALL SUPPLY CIRCUITS MUST BE DISCONNECTED.

IMPORTANT: ON COMPLETION OF THE FAULT FINDING TASK WHICH HAS REQUIRED THE BREAKING OR REMAKING OF THE ELECTRICAL CONNECTIONS, THE CONTINUITY, POLARITY, SHORT CIRCUIT AND RESISTANCE TO EARTH CHECKS MUST BE REPEATED USING A SUITABLE MULTI- METER.

Type of fault	Check
No domestic hot water or central heating	~230-240V Supply (24HR) ~230-240V Supply (Off Peak) System water pressure at 120 kpa (1.2 bar) External Off-Peak control Low pressure switch Manual re-set Over Heat thermostat 1st stage Manual re-set Over Heat thermostat 2nd stage Contactor Heating elements
No central heating but hot water at taps	~230-240V Supply (24HR) ~230-240V Supply (Off Peak) External controls External Off-Peak control Low pressure switch Heating elements Manual re-set Over Heat thermostats 1st & 2nd stage Temperature at bottom of store must be above aqua stat setting of 30°C Is central heating pump operating correctly?
Central heating but no hot water at taps or temperature diminishes after a short period	Auto air eliminator in closed position? Pump valves in the open position? Figure 16, page 9 Domestic hot water pump is not operating? Secondary expansion vessel pressure (must be 2.0 -3.5bar) Hot water blending valve? Blockage in the primary flow pipe into the plate heat exchanger?

3.1.1 Fault: No domestic hot water or central heating

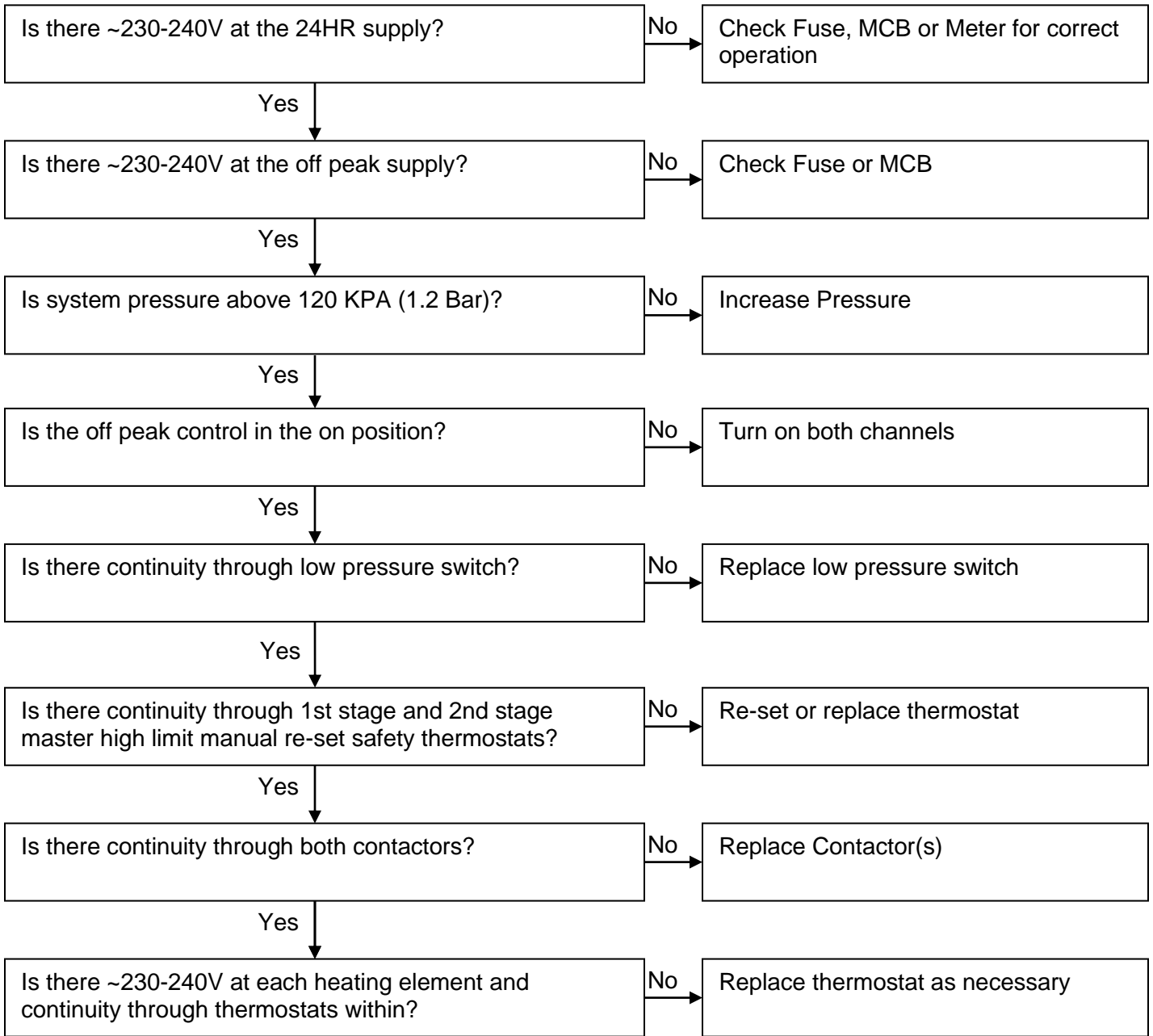



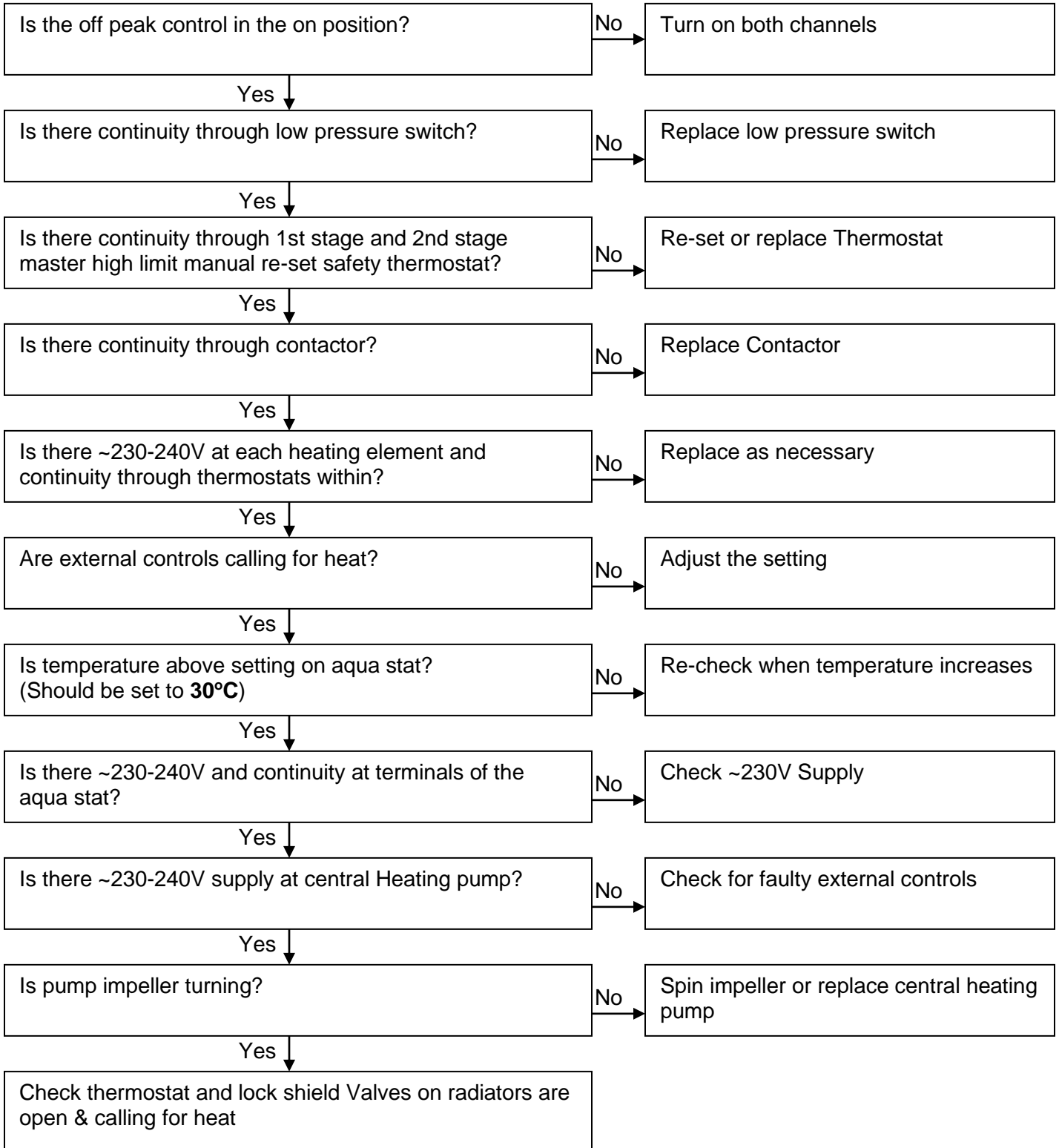

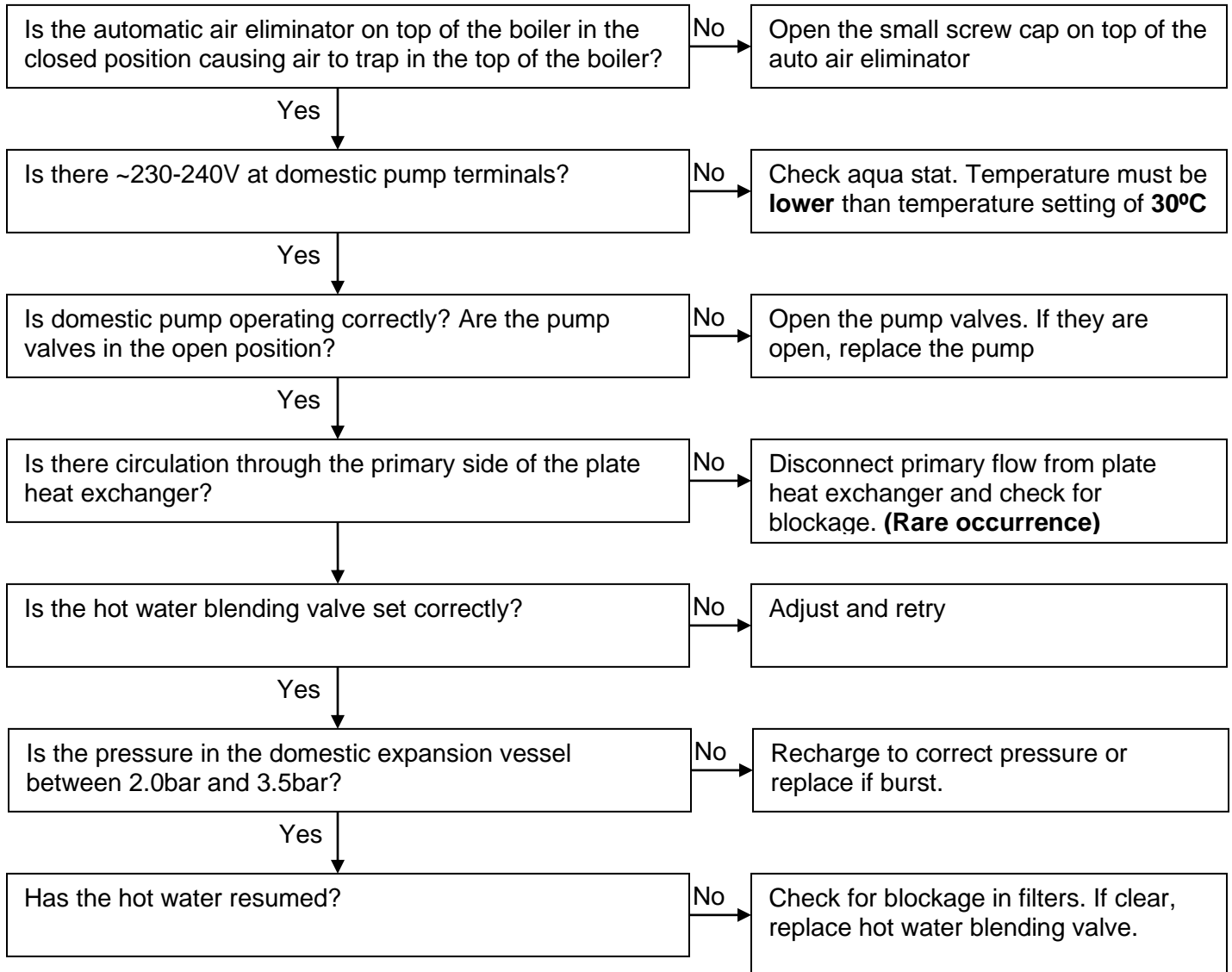

3.1.2 Fault: No central heating, but hot water at taps



3.1.3 Fault: CENTRAL HEATING BUT No hot water at taps



Fault Diagnosis E10 or single rate supply.

      
R3 R2 R1 LP HL1 HL2 POWER

NO POWER

LOW WATER PRESSURE

HIGH LIMIT 1 – TRIPPED – E10

HIGH LIMIT 2 – TRIPPED – E10







      

OFF PEAK CONTROL IS OFF OR BOILER HAS REACHED TEMPERATURE







      







OFF PEAK CONTROL – WINTER CHANNEL OFF
SUMMER CHANNEL ON







Fault Diagnosis E2000 (Scottish Power region of Scotland **ONLY**)







      
R3 R2 R1 LP HL1 HL2 POWER

      
NO POWER – INTERRUPTED SUPPLY – E2000

      
LOW WATER PRESSURE

      
HIGH LIMIT 1 – TRIPPED

      
HIGH LIMIT 2 – TRIPPED

      
BOILER REACHED TEMPERATURE

WARNING: FOR YOUR OWN SAFETY

SERVICING AND MAINTENANCE SHOULD BE CARRIED OUT BY A PERSON WHO IS COMPETENT TO DO SO.

3.2 MAINTENANCE

- Before commencing, refer to section 1. Installation

Checking the primary expansion

3.2.1 The primary expansion - internal (volume 42 litres) is internal of heating boiler. Its purpose is to take up expansion in the boiler and central heating system.

The expansion bubble automatically forms when the system is filled to the correct pressure

3.3.2 The secondary expansion vessel (volume 0.5 litres) is the white or silver vessel connected to the cold inlet of the boiler.

Its function is to take up expansion in the hot water pipe work and so protect the blender from damage.

The pressure can be accurately checked with the pressure relieved on the other side of the diaphragm. To do this, isolate the water supply to the Thermaflow boiler and open a hot tap. Water will run for a few seconds then stop.

Connect a pressure gauge to the car tyre type valve on the vessel. The pressure should register 200-350 KPA (2.0-3.5 Bar). Close the hot taps and turn the water supply back on.

3.2.3 Checking the inline strainer

Whilst the water is off, remove and clean the gauze in the brass strainer assembly. To remove the gauze for cleaning un-screw the brass plug.

3.2.4 Checking the hot water blending valve

With the store temperature fully recovered, run a hot tap and check the flow rate and temperature.

If the hot water has deteriorated suddenly (over less than a month) then this points to a problem with the blender.

A broken blender is usually linked to a loss of pressure in the secondary expansion vessel.

The expansion vessel protects the blender from damage when the water in the secondary system expands as the water re-heats after water is drawn off.

Check the pressure in the secondary expansion vessel as detailed previously in section 2.

If it does not hold pressure it will need to be changed. If this doesn't resolve the problem, it will be necessary to change the blender

Strip off the blender and check hot and cold mesh filters for blockage. (Clean if necessary).

3.2.5 Checking the concentration of corrosion inhibitor

We would recommend Sentinel X100, or equivalent. Dose appropriately according to the size of the Thermaflow and central heating system volume combined and in accordance with the inhibitor manufacturer's guidelines.

3.2.6 Preventing pump seizure in summer

To prevent seizure of the central heating pump we recommend you turn the central heating on for 30 seconds or so every few weeks throughout the summer.

Seized pumps can usually be freed. The air release on the pump can be completely removed. A small flat blade screwdriver can be inserted into the slot in the centre and rotated to free the pump.

3.2.7 Checking correct operation of electrical components

WARNING: BEFORE OBTAINING ACCESS TO TERMINALS, ALL SUPPLY CIRCUITS MUST BE DISCONNECTED.

3.2.8 Low pressure switch

To check correct operation of the low pressure switch, drain some water from the central heating system until the pressure falls below 0.5 bar, then check continuity between terminals 1 and 2 there should be no continuity between these terminals.

Re pressurise the boiler and re check there is continuity between the same terminals.

3.2.9 Control and high limit manual re-set thermostats

Check operation of the control and over temperature thermostats by checking for continuity between both terminals.

(YOU MAY HAVE TO REMOVE THESE THERMOSTATS IF THE BOILER IS STILL HOLDING HOT WATER. YOU CAN PLACE THE THERMOSTATS IN A BEAKER OF COLD WATER AND THEN CHECK FOR CONTINUITY ACROSS THE THERMOSTAT).

3.2.10 CONTROL THERMOSTATS;

There are three or four of these thermostats in total. One is fitted in each heating element. The control thermostats are individually preset.

They should not be tampered with. If a failure on one of the thermostats has occurred, take note of which element it was removed from and contact Thermaflow Ltd for spares and advice.

3.2.11 OVER TEMPERATURE THERMOSTATS;

(Manual re-set); there are two of these which will break the circuit to the coil on the contactor causing power to break to the heating elements.

One is fitted above the central heating pump and one further up on the boiler. This second stage over temperature thermostat is pre-set to **90°C**. **It should not be tampered with.**

If a failure on one of the thermostats has occurred you can re-set the thermostat by pressing the small reset button on the thermostat.

If the thermostat continues to fail in an overheat condition a fault may have occurred in one or more of the control thermostats within the heating elements.

Take note of which one it is and contact Thermaflow Ltd for spares and advice.

The second is also a manual re-set over temperature thermostat and is fitted on the boiler.

This is the 3rd stage manual re-set master over temperature thermostat. It will break the circuit to the contactor on over temperature.

It is preset to **95°C** and sealed and **should not be tampered with.**

This will indicate a fault has occurred on one or more of the control thermostats within the heating elements and will have to be investigated.

If it continues to fail in an over-heat condition the fault must be rectified before the appliance is turned back on for use.

If a failure has occurred, contact Thermaflow Ltd for spares and advice.

3.2.12 Checking the heating elements

Check the resistance between live and neutral terminals on the element.

Replace the element if the resistance is greater than 10 m ohms.

3.2.13 Checking circuit breakers

Switch each circuit breaker off in turn and check that continuity is broken to each element.

3.2.14 Checking the contactor

Turn the main isolator off (this should be situated adjacent to the boiler) you should hear a small click from the control box marked number **16** on the boiler schematic on **page 9** of this instruction manual.

This indicates that the contactor has disconnected the circuit to the heating elements.

Turn the main isolator on and off a few times and listen for this noise. This will indicate correct operation of the contactor.

3.2.15 Check the operation of the AQUA STAT

The Aqua Stat is positioned on the cold water inlet entering the boiler. **Make sure the external controls are calling for heat.** Remove the cover and turn the dial on the thermostat up and down and listen for a small click.

As you turn the thermostat dial up and down check if the central heating pump, (**positioned on the right side of the unit**) is switching **on** and **off** and do the same with the DHW pump on the left hand side. If this is the case, this indicates correct operation of the thermostat.